

Accuphase

CLEAN POWER SUPPLY

PS-1200V

- AC voltage stabilizer based on waveform shaping technology
- Superior waveform compensating power
- Excellent current capability
- Highly effective interference rejection
- Built-in meter allows monitoring of output power, input/output voltage, and input/output distortion
- Elaborate protection features
- Large "Super Ring" toroidal transformer





Tap into a totally clean source of AC energy, free from distortion and high-frequency noise. Revolutionary waveform shaping technology enables highly precise compensation, providing a pure energy source with 230 V AC $\pm 2\%$ (or 120 V AC $\pm 2\%$). Connect audio or video equipment for a drastic improvement in sound and picture quality. Monitor output power, input/output voltage, and input/output distortion on the built-in meter.

The Clean Power Supply components from Accuphas are revolutionary products that remove noise and impurities from the AC power line and improve signal quality by continually monitoring and shaping the power supply waveform. They have been widely acclaimed for drastically improving the sound and picture quality of audio and video equipment. The PS-1200V is a further upgraded version of the predecessor model PS-1200. The circuitry has been optimized to fulfill

even higher performance demands, and the power transformer that forms the heart of the system is now a high-performance type with even more muscle. Because the PS-1200V is a high-power version of the PS-500V, a single unit can deliver enough power to cover the requirements of almost any high-quality system.

The PS-1200V uses waveform shaping technology to turn the power from a regular AC outlet into a highly pure sine waveform for use as a stable and

uncontaminated energy source of A/V components. To achieve this, the PS-1200V constantly monitors the input voltage waveform and adds or subtracts exactly the required amount of correction. The compensation required by this innovative technique typically is only a fraction of overall power. The PS-1200V therefore operates with high efficiency and produces little heat, allowing it to be designed as a fairly compact and lightweight unit. Since it contains no oscillators or switching circuitry, the PS-1200V itself does not act as a source of spurious high-frequency noise.

Power supply waveform and PS-1200V output waveform

Almost every electrical device used in an household converts the AC supplied by the outlet into a DC current for powering its internal circuits.

This task is performed by a rectifier. As shown in photograph (A), the rectifier load current has a pulse waveform with a large current flowing momentarily in the vicinity of the voltage peak. This causes a voltage drop, resulting in clipping of the voltage waveform, as shown in photograph (B).

A clipped waveform with a high amount of distortion contains many unwanted frequency components, or harmonics. When passing through the PS-1200V, the deformed waveform is restored to its original sine wave pattern, as shown in photograph (C).

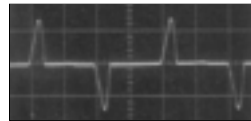

Photo (A) Current waveform of rectified load

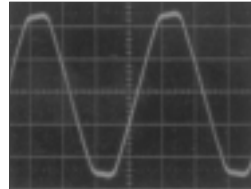

Photo (B) Voltage waveform of AC line (distortion approx. 3%)

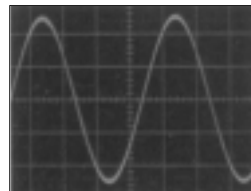
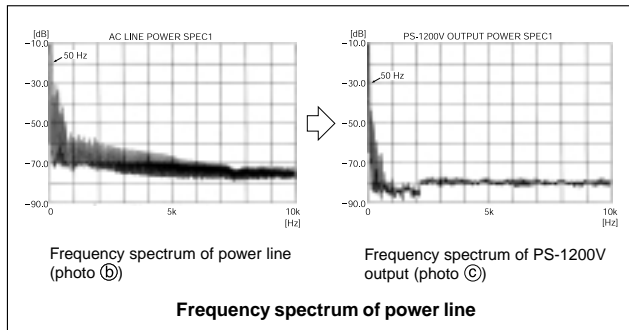

Photo (C) PS-1200V output waveform (distortion approx. 0.2%)



AC Voltage Stabilizer Based on Waveform Shaping Technology

The PS-1200V accepts AC power on the input side, processes it using internal control circuitry, and supplies it as clean AC power on the output side. Most of the AC energy from the input is carried over to the output. The loss introduced by the PS-1200V is very small, since it consists only of the power required for waveform compensation.

Figure 1 shows a block diagram of the unit. The signal from the secondary winding S_1 of the transformer reaches the adding/subtracting circuit and appears at the output as output voltage (e_o). A part of the output voltage is routed to the - input of the waveform comparator for waveform comparison. The S_2 signal from the transformer goes to the reference waveform generating circuit where it becomes the high-precision sine waveform (e_i) synchronized to the input frequency of 50/60 Hz. This sine wave signal is then routed to the + input of the waveform comparator to be used as a reference signal. By comparing the two input signals, a differential component is extracted.

Based on this information, the adding/subtracting circuit can provide exactly the required amount of compensation for turning the output into a high-precision sine waveform.

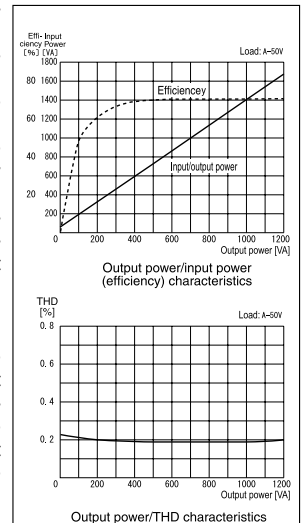

Fig. 2 PS-1200V Load Characteristics

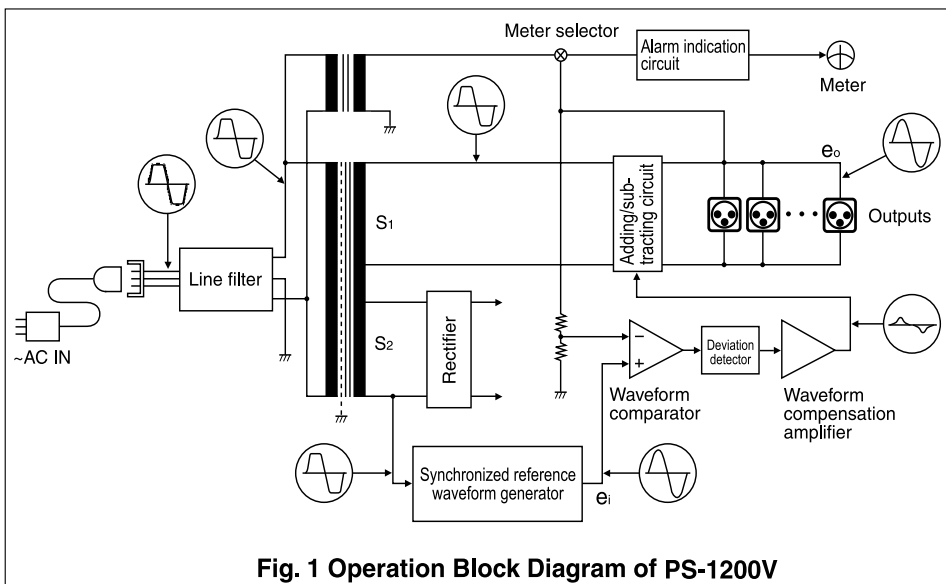

Fig. 1 Operation Block Diagram of PS-1200V

Excellent Current Capability

The power amplifier which performs waveform compensation is configured as a pure complementary symmetrical circuit using current feedback for unsurpassed operational stability. The output stage uses transistors rated for a maximum current of 15 amperes. These devices are connected in a 20-parallel complementary push-pull arrangement which boasts excellent current capability.

Superior Waveform Compensating Power

When the input voltage is 220 V (110 V), the voltage at the secondary side of the transformer will also be 220 V (110 V). To bring this to 230 V (120 V), 10 volts must be added, as shown in Figure 3 (a). Conversely, if the input is 240 V (130 V), 10 volts must be subtracted to yield 230 V (120 V), as shown in Figure 3 (b). In actual operation, the peak value of 10 V, namely 14.1 V is added or subtracted.

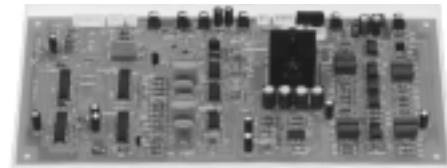
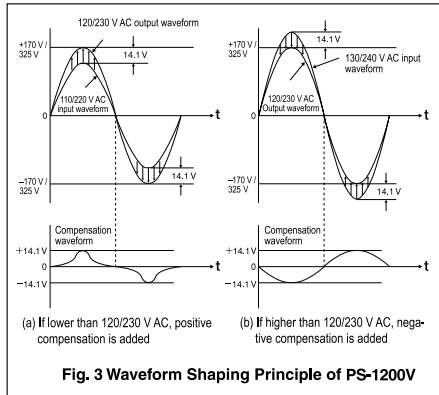

■ Assembly with reference waveform generator etc.

Comparing a precise sine wave synchronized to the input frequency with the output voltage yields a compensation waveform which is imposed on the output voltage. Consequently, for an input voltage range of 200-253 V AC (108-132 V AC) and a constant load, the output voltage is kept constant at 230 V $\pm 2\%$ (120 V $\pm 2\%$), with a maximum distortion ratio of 0.3%. These values demonstrate the outstanding waveform compensation ability of the PS-1200V.

Note:

The above explanation is for the 230 V AC version of the PS-1200V. Figures in brackets refer to the 120 V AC version.

Multiple Protection System Assures Total Operation Safety

When a problem occurs during operation, the circuit breaker integrated in the power switch immediately shuts off the power, to protect the unit

and any connected components.

- ① When input current overload occurs, such as when the output is short-circuited, the power is shut off.
- ② In case of momentary power overload, such as caused by inrush current when a component is switched on or when a power amplifier reproduces a peak passage in the music, a current limiter becomes active.
- ③ When DC voltage is detected in the output or when the output voltage exceeds the maximum rating, the output is switched off to protect connected components.
- ④ When the temperature of the internal heat sink or power transformer exceeds 110°C, the circuitry is automatically shut down.

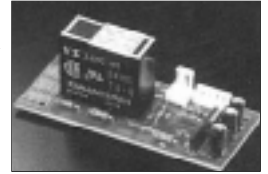

Assembly with protection circuitry

- Assembly with 20-parallel push-pull output transistors, waveform compensation amplifier for addition/subtraction, comparator for reference waveform and output waveform, etc.

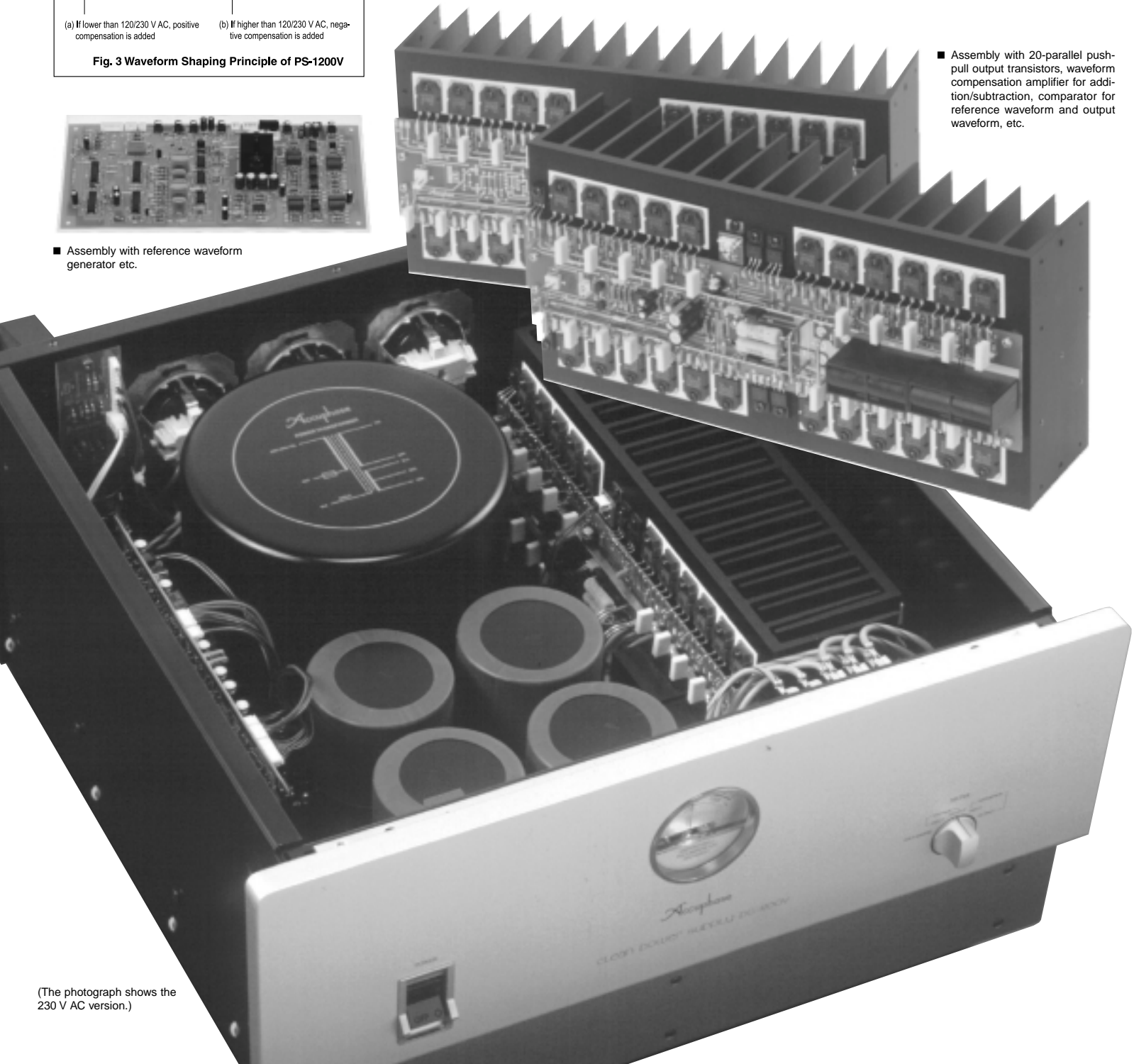

(The photograph shows the 230 V AC version.)

Highly Effective Interference Rejection

The input side of the PS-1200V is equipped with a line filter for removing any high-frequency noise components present in the power line, such as those generated by digital equipment. The primary and secondary windings of the power transformer are kept totally separate, and the fully shielded design shuts out any externally induced noise. Since the PS-1200V uses the AC feedback principle, output impedance is extremely low. This prevents any possibility of mutual interference between components connected to the outputs of the PS-1200V.

Built-in Meter Allows Monitoring of Output Power, Input/Output Voltage, Input/Output Distortion. Overload is Indicated by Flashing Meter Illumination.

The meter of the PS-1200V lets the user see at a glance how much power (VA) the connected equipment is consuming at any given time. This is especially helpful for components such as integrated amplifiers or power amplifiers whose power consumption differs considerably depending on the volume setting and actual music signal. When the maximum output power rating is exceeded, the meter illumination flashes as a warning indication.

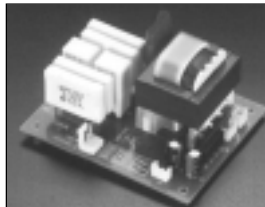

Assembly with input voltage/distortion monitoring circuitry

Strong Power Supply With Large "Super Ring" Toroidal Transformer and High Filtering Capacity

The power transformer plays a vital role in any power supply. The PS-1200V uses a large toroidal type rated for 1500 VA. Toroidal power transformers have large-gauge copper wiring on a donut-shaped core, resulting in very low impedance and high efficiency.

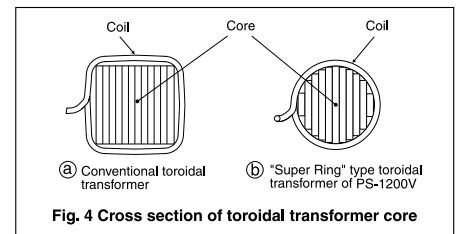
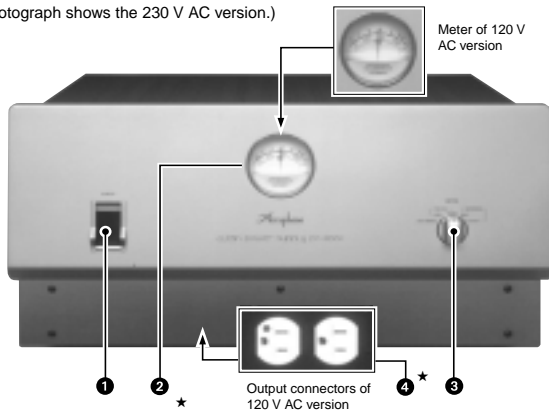

Fig. 4 Cross section of toroidal transformer core

FRONT PANEL

(The photograph shows the 230 V AC version.)



REAR PANEL

(The photograph shows the 230 V AC version.)

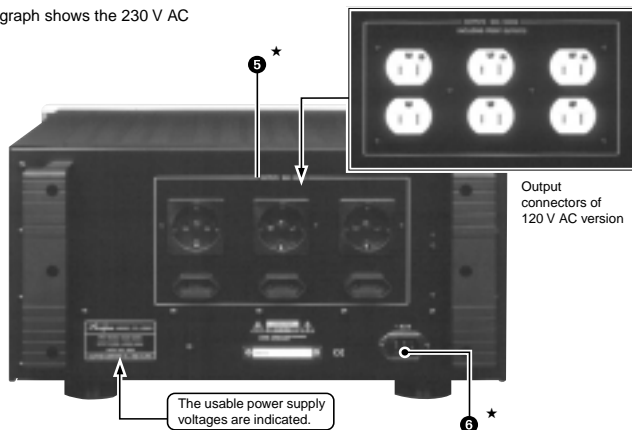

- 1 Power switch/circuit protector
- 2 Meter (Output power, input/output voltage, input/output distortion)*
- 3 Meter operation selector
VOLT-AMPERE VOLTAGE INPUT/OUTPUT
DISTORTION INPUT/OUTPUT
- 4 5 Output connectors (AC outlets)*
- 6 AC power connector (for supplied power cord)*

Remark

*The 230 V AC and 120 V AC versions of the PS-1200V differ regarding meter voltage indication, AC output connector shape, supplied power cord, etc. Make sure that you have the correct version.

Power Meter Indication and Load

The power consumption of electrical equipment, as indicated on the equipment itself and in catalogs and other documentation, is usually given in watts (W). This figure represents the so-called effective power which is stated according to legal requirements. However, the actual power drawn by the equipment is larger than the effective power. This is called the apparent power which is calculated by multiplying the applied voltage (230 V or 120 V) with the actual current. The unit for apparent power is VA (volt-ampere).

Since the value shown by the power meter of the PS-1200V in the "VOLT-AMPERE" position is the apparent power, the reading will be higher than the power consumption (W) given in catalogs and specification sheets.

- The rated power limit of the PS-1200V is 1200 VA for the 230 V AC version and 1000 VA for the 120 V AC version. When deciding on equipment to be connected, power consumption figures given in catalogs and the like can be used for a general estimate, but actual power consumption should be checked using the meter.
- The power consumption of integrated amplifiers and power amplifiers varies considerably depending on the actual audio output. After connecting such equipment, perform playback and verify that power consumption does not exceed the maximum rating when peaks in the music are reproduced at high volume levels.
- In case of overload, the meter illumination flashes. Reduce the load by reducing the number of connected components until the illumination stops flashing and stays constantly lit.

PS-1200V Guaranteed Specifications

	230 V version	120 V version
Rated output capacity	1200 VA (continuous)	1000 VA (continuous)
Rated output voltage	230 V AC ± 4.6 V	120 V AC ± 2.4 V
Rated output current	5.2 A	8.3 A
Output frequency	50 Hz or 60 Hz (identical to input frequency)	
Instantaneous peak current capacity	60 A	120 A
Output waveform THD	0.3% or less	
Rated input voltage	230 V AC	120 V AC
Input frequency	50 Hz or 60 Hz	
No-load power consumption	60 W	
Cooling principle	Natural air cooling	
Meter	0 - 1200 VA	
VOLT-AMPERE	The meter illumination flashes when an overload occurs	
VOLTAGE INPUT/OUTPUT (green zone of scale)	230 V AC $\pm 5\%$	120 V AC $\pm 5\%$
DISTORTION INPUT/OUTPUT	0 - 6%	
Dimensions	475 mm (18-11/16") width, 242 mm (9-1/2") height, 508 mm (20") depth	
Weight	38.4 kg (84.7 lbs.) net 48 kg (105.8 lbs.) in shipping carton	



Caution

- * The PS-1200V is available in 230 V AC and 120 V AC versions. The actual allowable voltage is indicated next to the AC power connectors on the rear panel. Be sure to check this indication before using the PS-1200V.
- * This product can be used only on a regular household AC circuit rated for 230 V or 120 V AC, 50/60 Hz. Using the product with portable AC generators, airplane or ship power generators or other types of power sources is not possible.
- * This product is designed to improve the quality of AC power supplied to audio or video components. Do not use it to power industrial type equipment or common household electrical appliances.
- * Do not use this unit for powering equipment where failure incurs a risk of injury or fatal accidents (medical equipment, aviation equipment, traffic control equipment, furnace and heating control equipment, safety devices, etc.)
Accuphase will not be liable for any problem occurring due to use of the PS-1200V with the above type of equipment.

Supplied accessories: • AC power cord



ACCUPHASE LABORATORY INC.

*Specifications and design subject to change without notice for improvements.

<http://www.accuphase.com/>

PRINTED IN JAPAN F015Y 851-0108-00 (AD1)